

MORTISE LOCK DETAIL

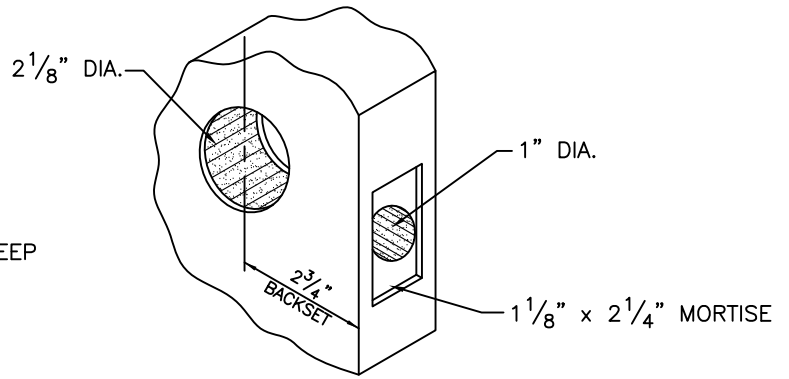

CYLINDRICAL LOCK DETAIL

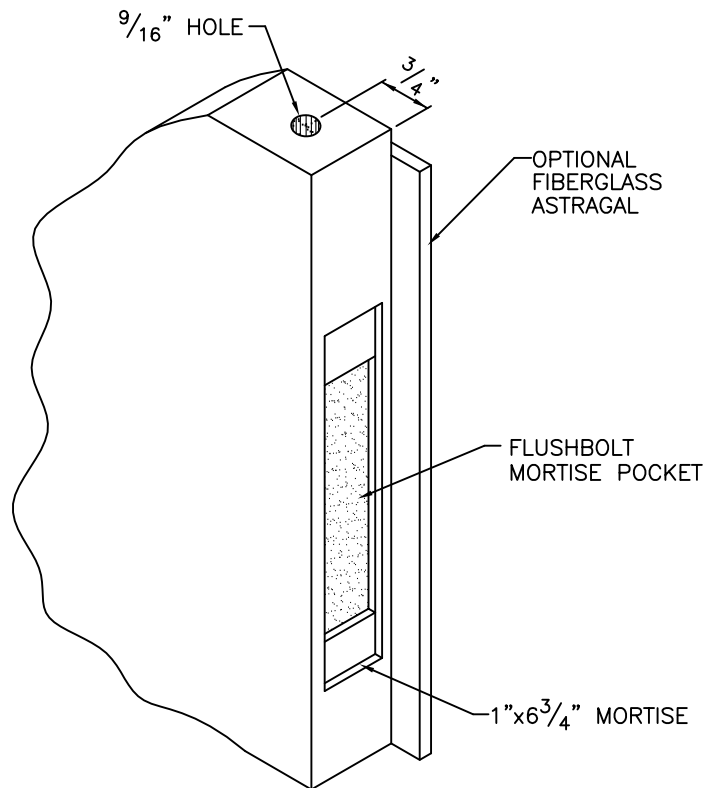

FLUSHBOLT DETAIL

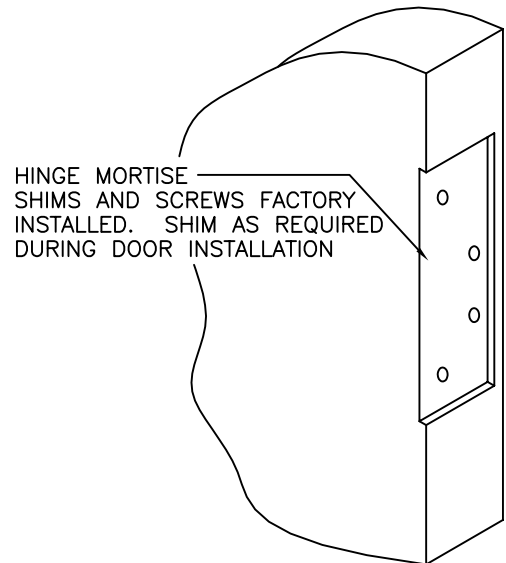

HINGE DETAIL



FIBERGLASS DOOR HARDWARE MACHINING DETAILS		
DATE 9/17/04	SCALE NONE	
DWG NAME DOORMACHDETAIL	DRAWN BY BG	